

AUROOM

Our Saunas Your Wellness

Sauna control unit

IMPERA D
IMPERA H

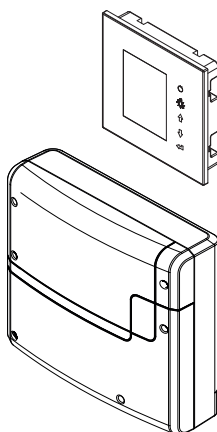

INSTALLATION AND OPERATION MANUAL

CE IPx4



Technical changes reserved

www.auroom.ee

ENGLISH

Contents

Delivery scope	4
Accessories	4
Technical specifications	5
General notes for sauna bathing	6
General safety notes.....	7
Mechanical installation	9
Relay box.....	9-10
Display panel	11
Temperature sensor	14
Electrical connections.....	16
Sauna heater connection.....	16
Sauna lamp connection	17
Connection of power extension units (LSG)	17
Wiring and connection diagrams	18-19
Temperature sensor connection	20
Humidity sensor	20
Benche sensor (2 nd sensor)	20
Connection overview (Impera).....	21
Vaporizer connection (Bi-O type heaters)	22
Humidity sensor installation and connection.....	22
Bench sensor installation and connection.....	23
Setup (commissioning)	24
Operation	26-36
Overview.....	26
Symbols (main navigation)	27
Symbols (settings and additional functions)	28
Graphic user interface / Climate conditions query.....	29
Operation and settings (main settings).....	30-33
Operation and settings (additional settings).....	34-36
Service level (setup and settings).....	37-40
Error messages and troubleshooting.....	41
The Switch-off rocker switch	42
Service address	43
Warranty	44
General conditions of service (ASB)	44

Scope of delivery

(changes are reserved)

1. Main electronic unit (with two-part front cover)
2. Control panel with colour display
3. Housing base for flush-mounted installation of the control panel, with mounting brackets
4. De-installation tool (for control panel)
5. Temperature sensor: a) housing, b) sensor board, c) overheat protection fuse, d) 2 mounting screws 4 x 40 mm, e) connection cable 5 m with RJ10 plug, f) 2-core white cable for overheating protection fuse 5 m
6. Connection cable (control panel - main block) with RJ14 / RJ10 plugs
7. Plastic bag with 3 mounting screws 4 x 25 mm (for main electronic unit)
8. 1 spare overheating protection fuse
9. 5 rubber cable glands
10. 1 installation & operation manual, 1 operation manual (for end users)



Accessories (optionally available):

- 2nd sensoritem 94.5725 (only for Impera D and H)
Humidity sensor.....item 94.5726 (only for Impera H)
coloured light control moduleitem 94 5996, 94 6007
Sound module.....item 94 5920, 94 5921
Remote start moduleitem 94 5782
SBM-WCI-01 web app module.....item 94 5987

Technical data

Voltage (power supply):	400 V 3 N AC 50 Hz
Switching capacity:	max. 9 kW resistive load, may be extended with a power extension unit (LSG)
Heating time limit:	6 h / 12 h / unlimited
Housing:	plastic, shatter-resistant
Display:	TFT colour display 55 x 74 mm (3,5" size)
Operation:	2 direct buttons for On/Off and light, jog-dial switch
Temperature control range:	30° - 115°C (dry sauna mode) 30° - 70°C (humid sauna mode - only Emotec H)
Humidity control:	proportional to time or optionally as per rel. air humidity (%) with an optional humidity sensor.
Sensor system:	Digital sensor with overheating protection fuse (STB) 142°C
Control characteristic:	Digital two-point control
Connection for fan:	min. 5 W, max.150 W (only fans without starting capacitor) <i>Please make sure to use only the fans compatible with the phase lead edge control. Otherwise the fan or the sauna control unit may be damaged!</i>
Connection for light:	min. 5 W (20 mA), resistive loads - max. 150 W, dimmable energy saving lamps - max. 35 W Lamps at conventional transformers - max. 60 VA. Attention: only dimmable lamps may be used!
Volt-free output:	 Fan and light output share a common 5 A fuse. contact's resistive load carrying capacity: maximum current: 16 A maximum voltage: 30 V DC / 250VAC
Start time pre-selection:	up to 24 h in advance
Switching automation:	Week timer with 4 switching programs per day
Error display:	Clear text error indication on the display
Outputs:	3 x RJ10 jacks for sensor connections 2 x RJ14 jacks for control panel and extension modules 1 x potential free contact (2 terminals)
Output S1:	maximal load 50 W / 50 VA, no capacitive loads allowed.
Terminal block area for power supply and steam generator connection:	0.5 – 2.5 mm ² rigid or flexible crimped wire, two cores with the same cross section per terminal may be connected
Terminal block area WM, 3, 4, light, fan:	0.34 – 2.5 mm ² rigid or flexible crimped wire Please observe the minimal cross section as per fuse protection of the line!
Card reader:	Micro-SD card reader in control panel
Ambient temperatures:	-10°C to +35°C
Storage temperatures:	-20°C to +60°C
Sensors:	may not be installed in corrosive or highly salty environment.
Control unit:	may not be installed in corrosive environment or in an environment which may cause water condensation.
Dimensions main block:	H 270 x W 300 x D 100 mm
Dimensions control panel:	H 127 x W 130 x D 25 mm (flush-mounting) recessed part 20 mm deep

Dear customer

You have purchased a high-quality technical device with which you will have years of sauna fun. This sauna control unit was designed and inspected according to the current European safety standards and manufactured at the factory in accordance with the quality management standard DIN EN ISO 9001:2000.

This detailed installation and operation manual has been prepared for your information. Please observe in particular the **important notes** and the information on electrical connection.

We wish you exhilarating recreational experience and lots of fun with your sauna!

Intended use

This sauna control unit is exclusively intended for the control of the sauna heater in a sauna cabin.

Any other use over and above the intended purpose is not considered as appropriate use! Compliance of the standard operation, maintenance and repair conditions is also an element of appropriate use.

The manufacturer cannot be held liable for deviating, unauthorized alterations and any resulting damages: the initiator of these changes bears the full risk.

General information

Please check whether the unit has arrived in perfect condition. Any transport damages should be immediately reported to the freight forwarder delivering the goods or you should contact the company that shipped the goods.

Please note that you will only be able to achieve an optimum sauna climate if the cabin with its air intake and ventilation, the sauna heater and the control unit are aligned to each other.



Please observe the information and stipulations made by your sauna supplier.

Sauna heaters heat up your sauna cabin using heated convective air. Here, fresh air is drawn in from the air intake which, when heated, rises upwards (convection) and is then circulated within the cabin. Part of the used air is pushed out through the vent in the cabin. This creates a typical sauna climate which can achieve temperatures of approx. 110°C measured directly under the ceiling of your sauna, dropping in temperature to approx. 30-40°C towards the floor. It is therefore not unusual to measure temperatures of 110°C on the temperature sensor hanging over the heater, whilst the thermometer hanging on the sauna wall, approx. 20-25 cm under the cabin ceiling, only indicates 85°C. The bathing temperature generally lies between 80°C and 90°C in the area of the upper bench when the temperature is set to maximum.

Please note that the highest temperatures are always generated over the sauna heater and that the temperature sensor and the safety limiter must be mounted there in accordance with the control unit installation instructions.

When heating up for the first time, you may notice a slight smell caused by evaporating lubricants used in production processes. Please ventilate your cabin before beginning your sauna bath.

General safety precautions

- This device can be used by children aged 8 upwards and by persons with physical, sensory, or mental disabilities, or who have inadequate experience and knowledge if they are supervised or if they have received adequate instruction in how to use the device safely and understand the associated risks. Children may not play with this device. Children may not clean or carry out any user maintenance if unsupervised.
- Children are to be supervised in order to make sure that they do not play with this device.
-  **Attention:** It is forbidden to install the control box in a closed switch cabinet or behind a wooden panelling!
- The electrical installation may be done only by a qualified electrical technician.
- You must comply with the regulations of your power supply company and applicable VDE regulations (DIN VDE 0100).
-  **WARNING:** Never attempt repairs or installations yourself, as this could result in serious injury or death. Only a qualified technician may remove the housing cover.
- Please note the dimensions in the assembly instructions, especially when installing the temperature sensor. The temperature above the oven is critical for the temper-

ature setting. The temperature can be held within operating parameters and a minimal temperature gradient inside the bench area of the sauna cabin can be achieved only if unit is assembled correctly.

- The device may only be used as intended as a control unit for sauna ovens up to 9 kW (up to 36 kW when combined with a contactor box).
- Completely disconnect the control unit from the electrical circuit, i.e. flip all circuit breakers or the main circuit breaker during each installation or repair.
- Please note the safety and installation information from the sauna oven manufacturer.
- Always heed the specifications and instructions of the cabin manufacturer, too.

Attention!

If control units with remote control options* are used, protection against switching on if the heater is covered is required. (e.g. cover protection rail type 1-5).

**Remote control = setting up, controlling or adjusting a unit by a command that can be given out of view of the unit by means of transfer media such as telecommunication, audio technology or bus systems. (this also includes weekly timers)*

 When designing the sauna cabin ensure that the external exposed glass surfaces only reach a maximum temperature of 76°C. If necessary, protective features need to be fitted.

 **Attention!**

Dear customer,
according to the valid regulations, the electrical connection of the sauna heater and the control box has to be carried out through the specialist of an authorized electric shop

We would like to draw your attention that in case of a warranty claim, you are kindly requested to present a copy of the invoice of the executive electric shop.

 **Attention!**

Only the original spare parts may be used.
Any modification of the cables included in the delivery can lead to malfunctions and is not permitted.
Any unauthorized technical alteration makes the product warranty void.

Installation of the main electronic unit

The main electronic unit (relay box) may be installed only outside sauna cabin. The recommended places of installation are the outer sauna wall or a plant room (technical room). The installation on the sauna roof is also possible. If empty ducts for connection cable are already available, then they usually predetermine the installation position. The installation shall be carried out as follows:

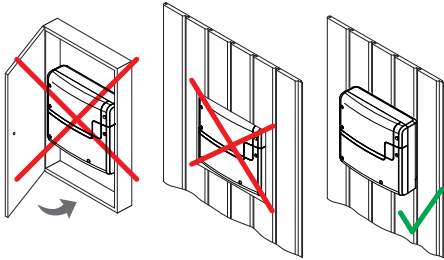

⚠ Attention: The relay box may not be installed in a closed switch cabinet or behind a wooden panelling!
Risk of overheating! Fire hazard!

1. Take the lower part of the front cover off the relay box. For this undo 3 fixation screws, then pull the cover slightly downwards and take it off. See the fig. 1 for details.

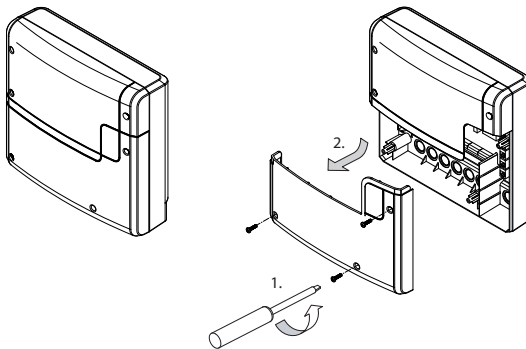

Fig. 1

2. The relay box has three mounting holes on the rear side. Refer to fig. 2 below for dimensions in order to mark the position on the wall (template). The central upper screw shall be used to hang the relay box onto it with the corresponding opening on its rear side. Two lower screws shall be used to secure the housing to the wall after it is hung on the upper screw.

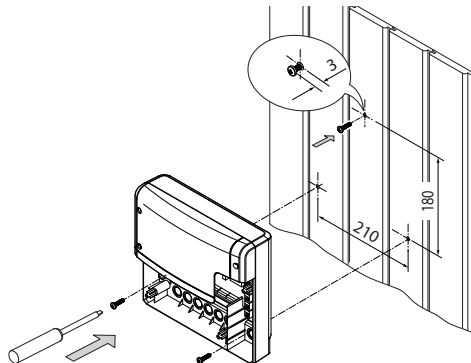

Fig. 2

3. Hang the housing on the central upper screw. Make sure that this screw stands out approx. 3 mm from the wall surface. If the connection cables shall be connected from the rear, knock out the corresponding openings in the housing and insert the supplied cable glands (rubber cable holders) into these openings. Pull the cables through them into the housing.

Secure the housing with two mounting screws 4x25 mm through the corresponding holes as shown on fig. 3 below.

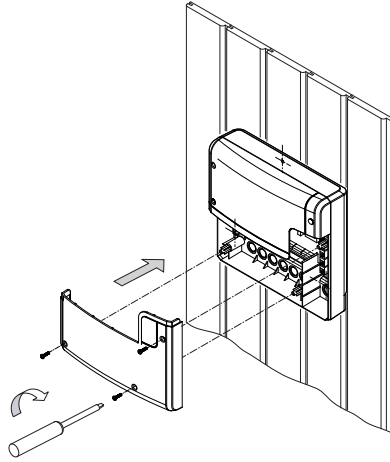

Fig. 3

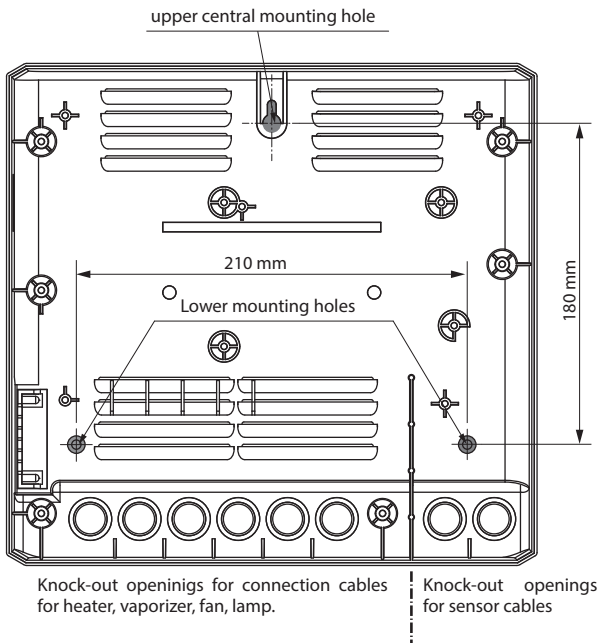

Fig. 4

Control panel

Installation place

The control panel may only be mounted outside the sauna cabin. If ductwork is already provided for electrical installations then the position of the control unit is predetermined by that. The control panel is designed for flush-mounted installation into the sauna wall or a similar adjacent wall. The installation shall be carried out as follows.

First of all determine the installation position. Ideally it should be at the eye sight height, as shown on fig. 5

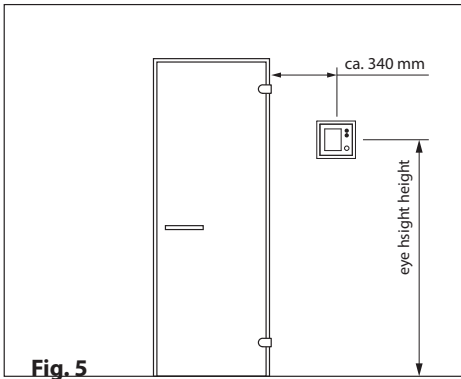

Make a cut-out in the wall with dimensions 117 mm height x 120 mm width.

Be careful not to make it too large, the flange of the control panel has 5 mm.

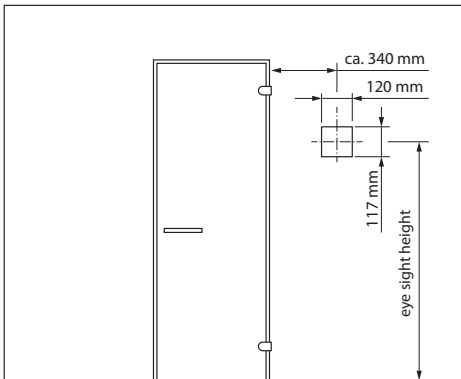

Cable connection

Draw the connection cable from the relay box to the control panel.

The connection cable may be laid only between the outer sauna wall and insulation layer to prevent overheating (Fig. 7).

The insulation should ensure that the temperature at the outer sauna wall may not exceed 75° C.

Pay attention to that the bigger plug (RJ14) shall be oriented towards the relay box and the smaller plug RJ10 towards control panel.

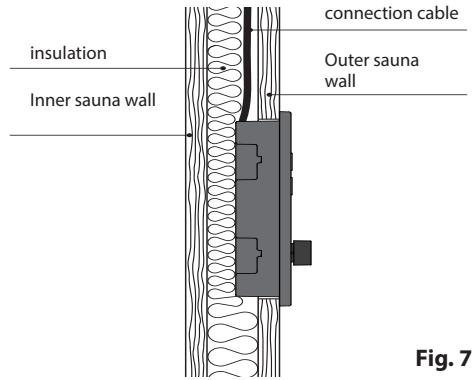

Use the supplied 5 m connection cable with RJ10 plug (control panel side) and RJ14 plug (relay box side).

If necessary this connection line may be extended to approx. 100 m length. For this you will need to use a standard coupling RJ14/RJ14 and the extension cable with RJ14 plugs in required length. The coupling and extension cable may be purchased from specialist dealers.

Flush-mounted installation

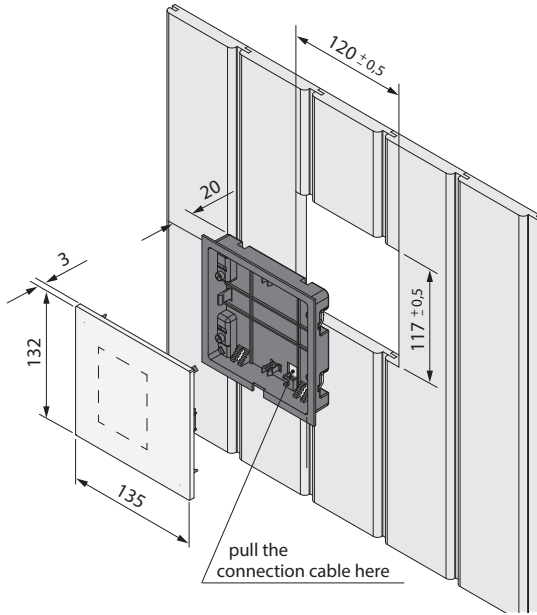

Wall aperture:
Width 120 mm
Height 117 mm
Depth min. 20 mm

Advice:
Pay attention to the correct orientation of the housing base, the opening for connecting cable should be at the bottom side as shown on fig. 8

Fig. 8

Installation of the housing base

First install the housing base (wall panelling up to 30 mm).

1. Loose 4 screws with mounting brackets on the base
2. Adjust the brackets to the designated wall panelling thickness (<15 mm or 15-30 mm)
3. Pull the connection cable through the opening in the housing base.
4. Insert the housing base into the wall opening.
5. Flip the brackets 90° to outside and tighten the screws - the housing base will be pulled to the wall panelling from inside and fastened in the wall opening.

By wall panelling < 15 mm (factory default)

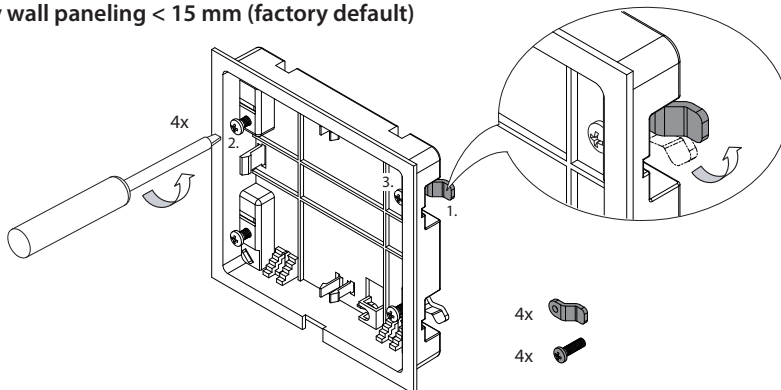

Fig. 9

By wall paneling 15 - 30 mm

turn the brackets around

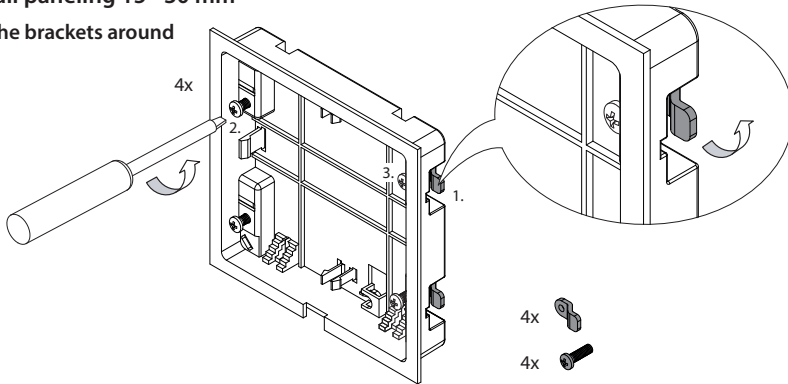

Fig. 10

By wall thickness > 30 mm

Leave the brackets in original position and mount the housing through the mounting holes in the bottom using 4 screws.

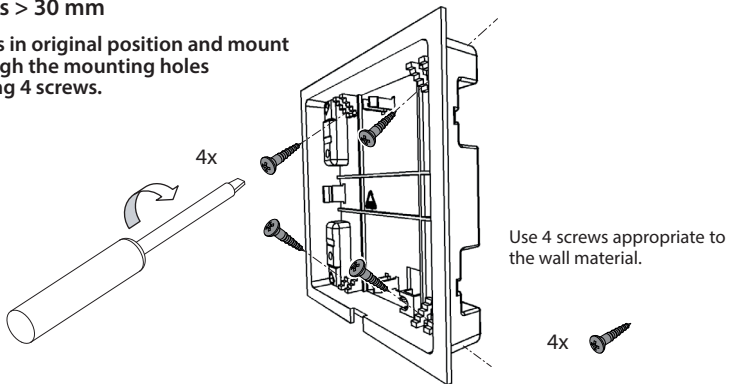

Fig. 11

Installation of the housing upper part (control panel with display)

Place the control panel directly in front of the housing base and pay attention to the correct orientation (jog-dial switch shall be at the bottom right). Plug in the connection cable with RJ10 plug which you pulled through the housing base.

Now press the control panel carefully into the housing base until you hear a click sound (hooks of the upper part should snap into the holders in the base). Make sure the control panel sits reliably in the base part.

Installation hint: When you lay the connection cable do not pull it too tight, allow some extra length around the base, so that later you can take the control panel out of the base easily while still having it connected.

How to remove the display panel

In order to remove the mounted display panel from the bottom housing use the included removal tool or a similar suitable tool like a flat headed screwdriver. Insert the removal tool into the groove at the bottom side between the display panel and the bottom housing and pull the display panel carefully out until it is released from the holders. Then take it completely out. Do not apply excessive force, do not insert the removal tool in any other place as this may damage the control unit.

Do not pull the display panel by the glass!

Connection of sensor cables

Do not lay sensor and power supply lines together, or lead them through the same duct. This can lead to interferences in the electronics, such as “fluttering” in the relays. Connect the cable shielding (if present) to ground in the control unit.

Please observe that the following dimensions relate to the values stipulated during the unit inspection acc. EN 60335-2-53. The heater sensor must always be installed at the point where the highest temperatures are to be expected. Fig. 12-14 provide you an overview of the mounting point of the sensor.



Installation of the temperature sensor

Make sure that there is no deviating mounting position of the sensor, specific to the sauna heater (check the installation guide of the sauna heater).

1. Mount the heater sensor in cabins up to 2 x 2 m according to fig. 13, in larger cabins according to fig. 14.
2. Drill a hole to lead the cable through, preferably through the middle of one of the wooden planks.

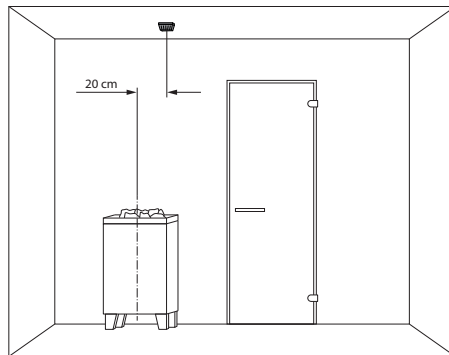

Fig. 12

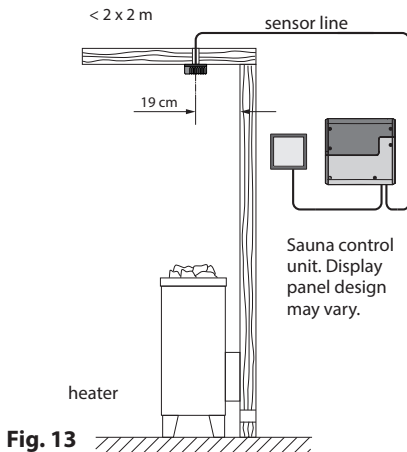

Fig. 13

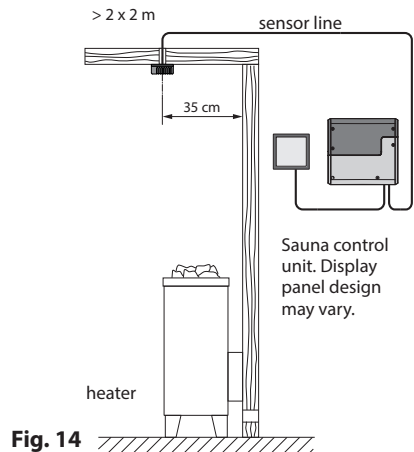
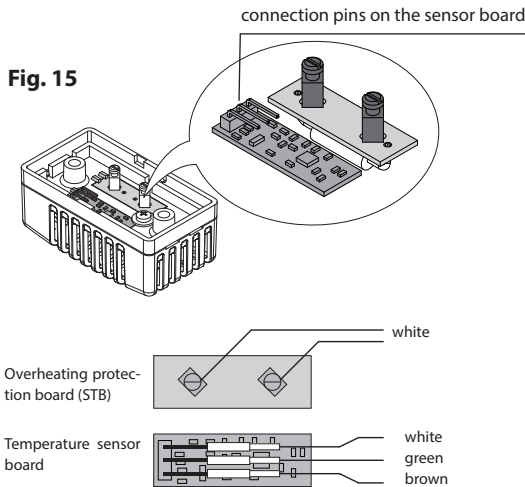

Fig. 14

3. Lead the sensor cable (red) and the limiter cable (white) through the drilled hole and connect both cables to the main relay box as advised on pages 18-19.
4. Connect the sensor cable to the sensor board according to fig. Make sure the connections are correct. Connect the limiter cable (2-core white cable) to the limiter board (STB).
5. Mount the sensor to the ceiling plank using two supplied screws and attach the housing cover.
6. After completed installation and correct commissioning of the control unit, the sensor line for overheating protection must be tested for proper functioning. Disconnect one of the wires of the white cable at the STB board in the sensor housing - the respective error message shall appear on the display. Re-connect the wire to make the error message disappear.

Temperature sensor - connections:



Attention:

Please pay attention that by the installation of the cable lines for sensors and display panel it is not permitted to pull the cable by the modular plug. If you use a help to draw the cable through the ducts it must not be attached to the plug but to the cable only! Pulling the cable by the plug may damage it and cause loose contacts resulting in malfunction of the control unit. In such case the warranty will be void and the cable should be replaced.

Make sure to observe the correct wire connection order on the temperature sensor board as shown on fig. 15.

Temperature sensor - installation overview:

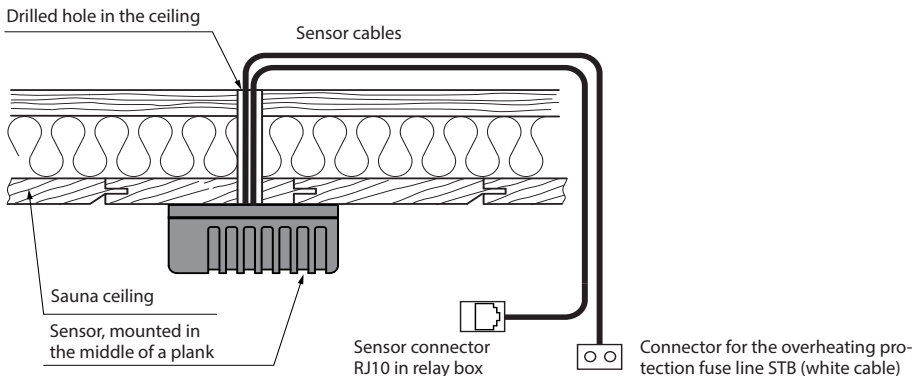

Fig. 16

Electrical connection

The electrical connections may only be carried out by a certified electrician in compliance with the guidelines of the local power supply company and applicable legal regulations (e.g. VDE norms for Germany).

In general, there may be only one permanent connection line to the network. Furthermore equipment should be provided that makes it possible to disconnect the system on all phases from the power supply with a contact gap of minimum 3 mm.

All electrical installations and all connection lines that are installed inside the sauna cabin must be suitable for an ambient temperature of at least 170 °C.

The power supply line shall be laid to the control unit and connected to the power input terminals.

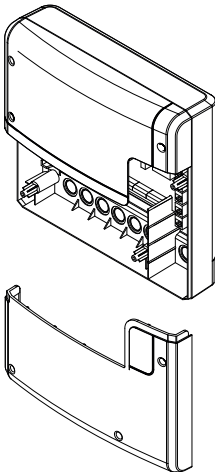

Relay box, lower front cover opened

The power supply cable shall be laid to the main relay box and connected to the power input terminal as per connection diagram (see wiring diagrams, page 18-19).



Sauna heater connection

Install the sauna heater and the vaporizer in front of the air intake according to the manufacturer's installation instructions.

Draw the silicone cable through the ductwork to the relay box and connect it to the appropriate terminals as directed in the wiring diagram.

Make sure to observe the wiring diagrams on pages 18 - 19 with the corresponding terminal connection scheme.

Notice: In case there is no ductwork available drill a hole next to the air intake opening and run the heater line through this hole to the outside and to the appropriate terminals in the control unit. The silicone line must be covered to protect it from outside influences. Therefore, use a suitable cable-duct or a PVC-pipe through which you can run the line up to the power unit.

Special advice for connection of Bi-O sauna heaters to control unit.

Attention!

By working vaporizer the power output line „W“ will be diverted to the „Wb“ line of the vaporizer.

The sauna heater section will then operate with 2/3 of the total power.

(if no LSG 18 H or LSG 36 H is used)

Fig. 17

If a vaporizer is connected and the operation mode is set to humid operation, then upon switching the unit on the vaporizer will be energized for a short time. This allows you to prove that the vaporizer is functional and operates correctly. It will then switch off until the temperature reaches 10°C below the target level and then switch on. This ensures faster heat up times and prevents that the steam is supplied into a still too cool sauna cabin.



Sauna lamp connection



The sauna lamp must have the protection class of at least IPx4 and should be resistant to the ambient sauna temperatures. The sauna lamp may be installed at any location but never close to the rising hot air of the heater.

Only dimmable lamps may be used. The control unit will detect strongly inductive loads and will adjust the phase edge control accordingly.

Make sure to observe the specifications of the light output of the control unit for each light type.



Notice: By connection of not dimmable lamps there is a risk of damaging either the illuminant or the control unit. No warranty claims may be accepted in this case.



Connection of the power extension unit

The switching capacity may be extended with an external power extension unit (LSG), in order to connect and operate the sauna heaters above 9 kW power.

For connection details please refer to the installation and operation manual for the respective LSG model.



Fan

Only use fans whose speed can be controlled via phase control. The fan must have the splashwater protection class (IPx4) and must be resistant to the ambient temperature. The fan can be mounted anywhere, however never close to the rising flow of hot air from the stove and must be positioned as far away as possible from the IR spot (it may not be in the light path of the spot).



Heating time limitation

The maximal heating time may be limited with the jumper #5 on the main board of the relay box. The limitation may be set to 6 hours, 12 hours or to unlimited.

If the control unit has been set to private (domestic) use, then the heating time will be automatically limited to 6 hours.

The jumper setting will override the software settings.



Potential-free contact

The terminals „3“ and „4“ on the main board of the relay box are the terminals of the normally open (NO) contact of a relay. Both terminals have no further connection and are therefore potential-free (voltage free). You can integrate this NO contact into any circuit, in order to switch an external power load or to relay a switching signal. The max. load on the potential free contact, depending on whether AC or DC shall be switched, is given in the specifications on the page 5.



Attention! If you use the terminals L1, L2 or L3 to power the circuit connected to the potential free contact, then the connection line should not be overloaded. If necessary, the load (consumer) connected to the potential free contact should be additionally protected and provided with a separate power supply.

Installation diagram 6 [USD / ; _ bWSD/DI

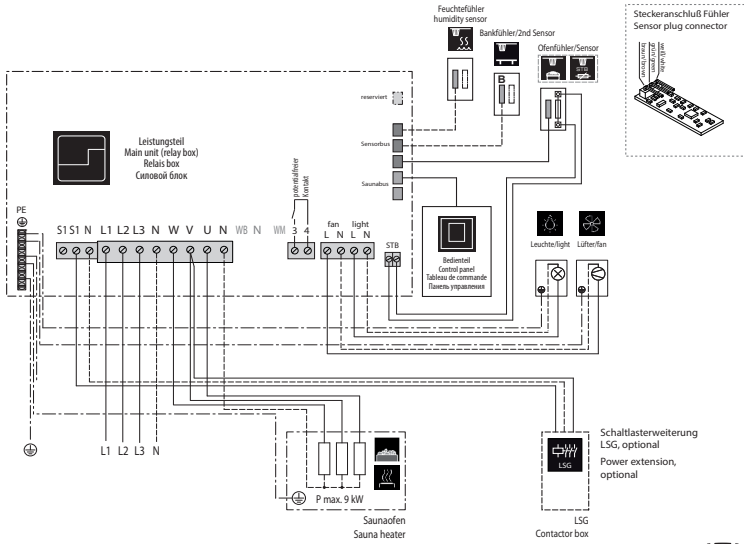

Terminal layout on the main board (relay box)

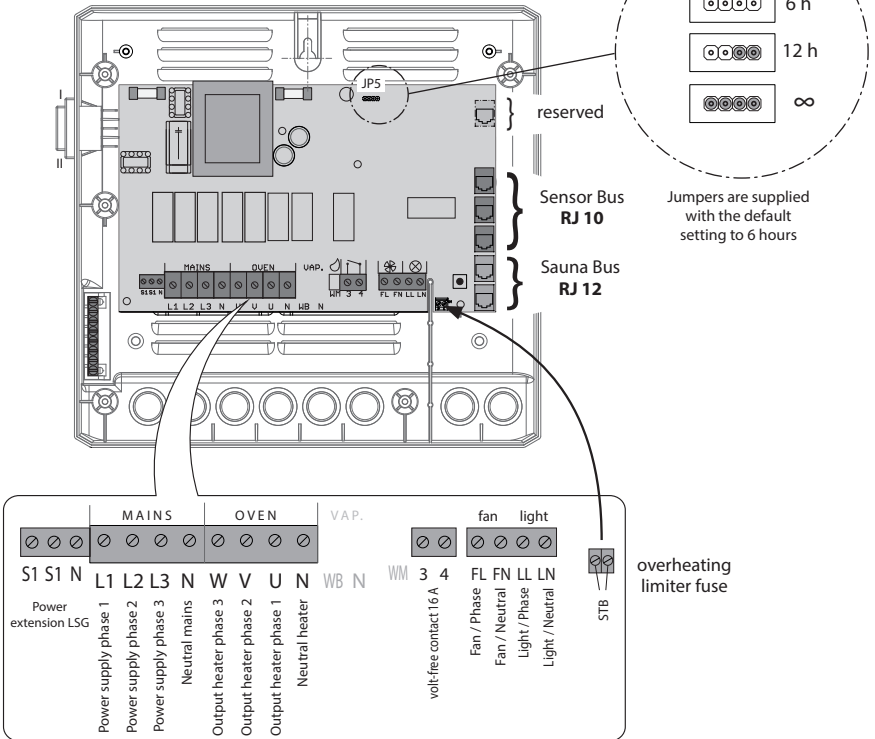

Installation diagram 6[LSH / ;_ bVSH/Hi

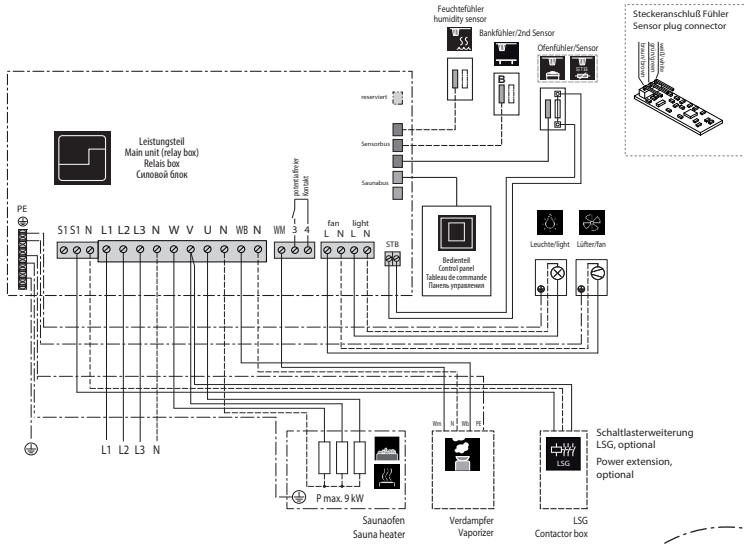

Terminal layout on the main board (relay box)

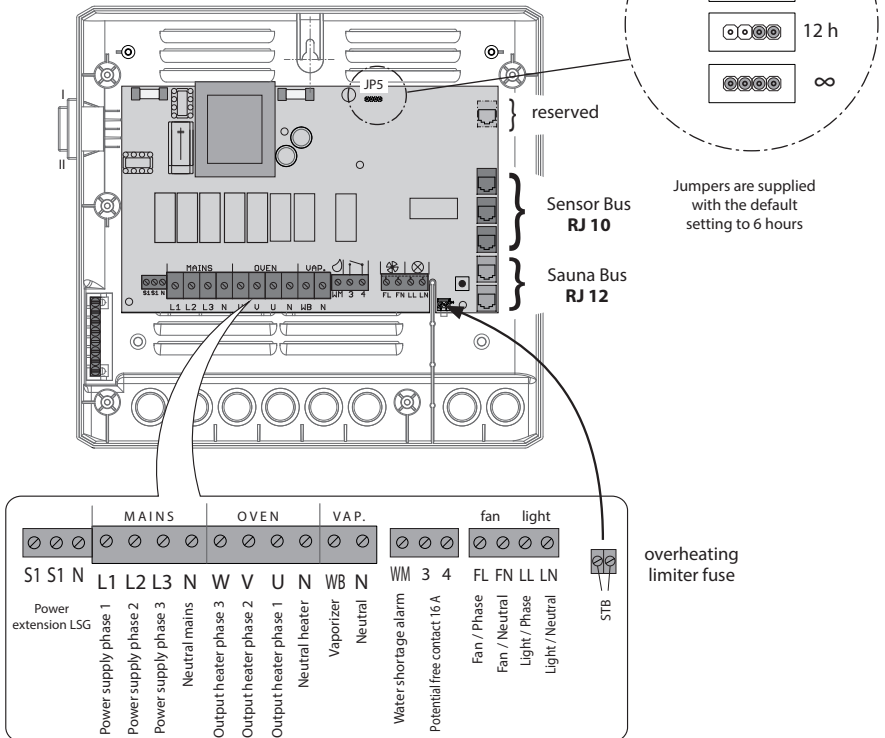

Temperature sensor

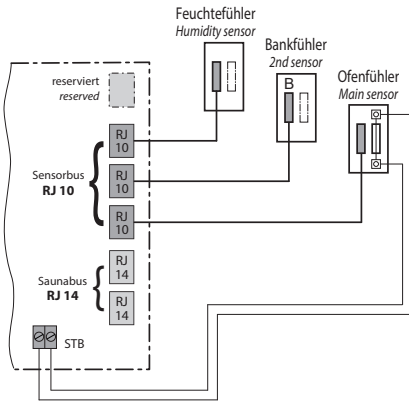

ATTENTION!

Connecting a sensor to the sauna bus connector (RJ12) may damage the sensor and the main board of the control unit!

The sensors are connected via RJ10 modular plugs to one of the corresponding sensor bus RJ10 jacks on the main board of the relay box as shown on the left. The connection order may be chosen freely. The sensor bus supports hot-plugging, sensors may be re-connected while the control unit is switched on and will be detected and configured within 2-3 seconds.

The white cable from the overheat protection fuse in the sensor should be connected to the 2-pin STB connector on the main board.

Do not try to plug the sensors into the sauna bus connectors (two lower RJ12 jacks), this will damage the sensor and the main board.

Humidity sensor (optional, for H series)

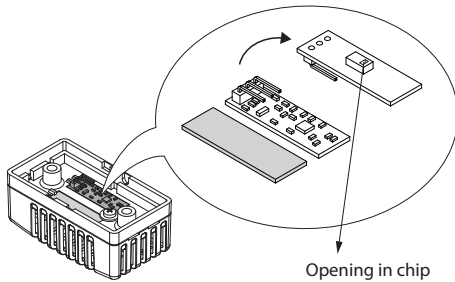

For further details please refer to page 22.

2nd sensor (optional)

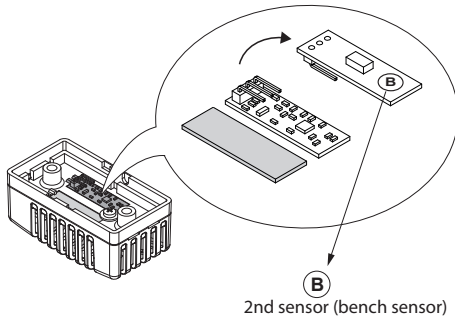

Pin-type connectors in sensor

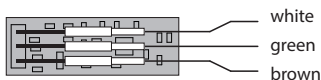



Vaporizer connection

Only for „H“ series sauna control units.



ATTENTION: pay particular attention to the correct connection of the WB and WM terminals. By swapped connection the detection of water shortage in the vaporizer will be disabled and the protective thermo fuse will be bypassed. The vaporizer may overheat! **Risk of fire!**

Connect vaporizer as shown on the connection diagram given below.

Make sure to use the appropriate heat-resistant silicone cable with min. 1,5 mm² cross section for vaporizer connection.

EOS control units will detect water shortage if there is zero potential at the Wm terminal of the control unit.

Pay attention to the maximum switching power of the control unit vaporizer output. If the total power of the vaporizer(s) exceeds the switching power of the control unit you will need an external power switching relay box or contactor box like LSG18H model.



Attention: Always connect the neutral (N) terminal at the sauna heater. In humid mode one phase will be switched off, the power load distribution will not be proportional. As a result the N line will not be currentless.

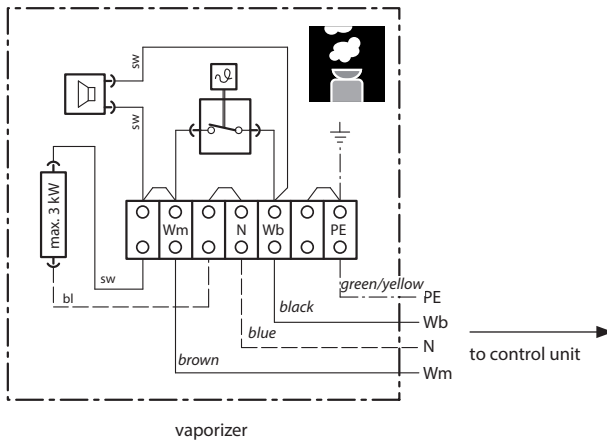



Installation of the optional 2nd sensor

Place of installation: The 2nd sensor (bench sensor) shall be mounted on the ceiling over the rear bench opposite to the sauna heater (see examples on Fig. 22).

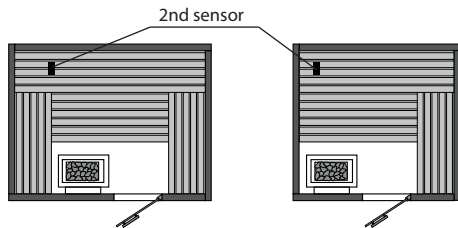

Fig. 22

The bench sensor is connected with a 3-core wire silicone cable with RJ10 plug to one of the free sensor bus jacks in the relay box as shown on the Fig. 23. Cable connection on the board inside sensor are shown on Fig. 24.

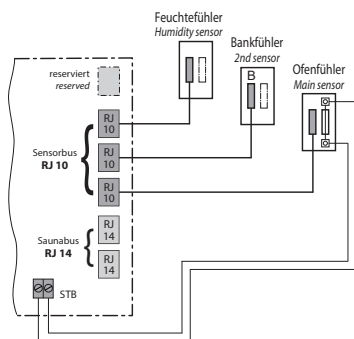

Fig. 23

By correct connection the sensor will be automatically detected and configured. The display will show the following symbol during start-up.



Display symbol:

The sensor symbol will be displayed either on the start screen (Dicia, Impera models) or in the temperature query submenu (EmoTouch models).

If the 2nd sensor is faulty the temperature will be controlled via the main sensor over the heater.

After the fault is rectified the 2nd sensor will be automatically detected and configured upon the new start of the control unit.

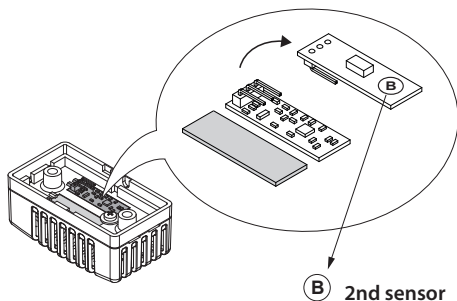

Fig. 24

The 2nd sensor is supplied including 5 m 3-core wire silicone cable with RJ10 plug. This cable shall be connected to the sensor board as shown on the fig. 24. For installation purposes the connection may be easily disconnected (pin-type connectors).

If the 2nd sensor is connected it will be used to control the temperature in the sauna. The main sensor will function only as the overheating protection (139°C limitation).

This allows to improve the air circulation in certain situations, for instance in very large saunas or by complex cabin layouts, and to achieve faster heat distribution to remote parts of the sauna.



Longer connection cables are optionally available.

Putting into service (initial setup)

Setup after initial start or after a reset



The Impera control unit allows fast and intuitive configuration in several steps by commissioning during the first start or after a system reset.

Select language

Select the required language with the  or  buttons and confirm your selection by pressing briefly on the enter button .



You can choose from 19 languages:

BG, CRO, CZ, DE, DK, EN, FIN, FR, HU, IT, NL, PL, RO, RU, SE, SK, SLO, SP, TR.

Only 9 languages are shown on the display at once. Press the key  or  to show the hidden languages.



Time

Set the current time. Set first the hours and confirm the setting by briefly pressing the enter button , then set the minutes and again confirm your selection by briefly pressing the enter button .

Date

Set the date, month and year in the same manner.

Set the sauna use type

This step configures the essential setup for the sauna use. The control panel will ask several questions and will set the scope of appropriate features according to the selected options.

1. **Is the sauna for private or commercial use?**

Select the applicable option and press to confirm:



for private use, or



for commercial use

2. **Is the sauna installed in the EU?**

Select the applicable option and press to confirm:



- yes, in the EU, or



- no, outside EU.

3. **Safety system as per norm EU 60335 for remote switching / preset timer available?**

Select the applicable option and press to confirm:



- yes, available, or



- no, not available.

4. **Select the heater type (only by ;_ bVMS H/Hi).**

Select the applicable option and press to confirm:



- dry sauna heater without vaporizer (or with disabled vaporizer)



- sauna heater with vaporizer (only for Impera H/Hi).

The setup is now complete and the control unit will switch to the standby mode.

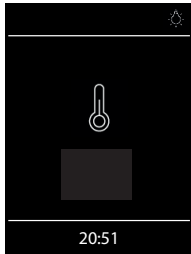

Display in standby mode by dry (Finnish) sauna operation (Impera D/Di und H/Hi).

Cabin light switched on.



Display in standby mode by humid (Bi-O) sauna operation (nur Impera H/Hi).

Cloud symbol appears to indicate the humid mode.
Cabin light switched on.

Operation

Control panel - overview

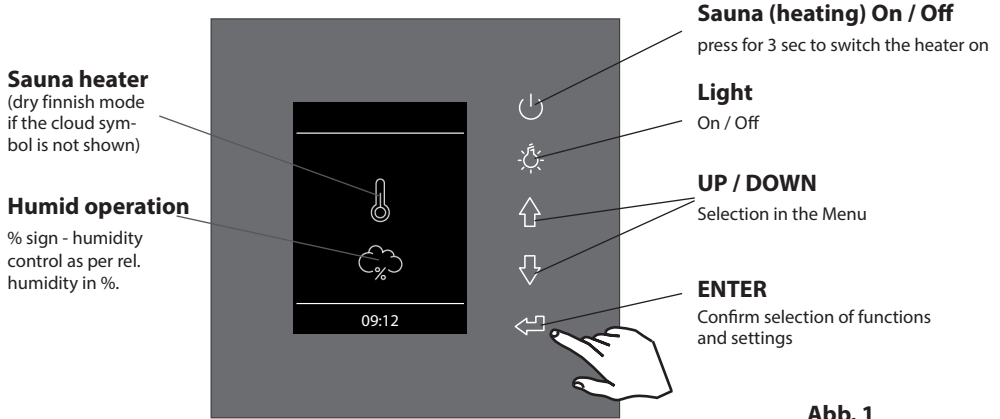

Switching your sauna on / off

In order to switch the sauna heater on press the button for 3 sec. The sauna will switch on after the Countdown with the preset parameters (e.g. temperature, etc.). To switch off press the button again shortly.

Switching the light on / off

Press the button on the front panel to switch the light on or off.

Settings

Press the button or to reach the settings menu. Es öffnet sich das Fenster wie in der Abb. 2 dargestellt.

By Impera H models (with enabled vaporizer) the symbol for a quick selection between the dry and humid sauna mode will be shown at the first place.

Settings interface by Impera H. The symbol for dry or humid mode selection is shown as the 1st option

Settings interface by D or Impera H (with disabled vaporizer)







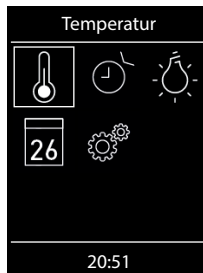

Abb. 2

Hint: if the display of the control panel remains dark after switching the power supply on please check the position of the unit's main switch (Switch-Off rocker switch) located on the main electronics unit (relay box). See chapter "Switch-Off switch" for more details.

Operation principle

Press the button  or  in order to select a function (icon). Press shortly the ENTER button  to open this function. Press the buttons ,  to change the value (changed value turns from white to green). Press the ENTER button  to save (confirm) the setting and exit, the control panel will then return to the previous (upper) menu.

Symbol description - main navigation menu



Operation type (only Emotec H)

Selection between dry and humid mode (the vaporizer must be connected and enabled).



Finnish sauna mode

Selection for operation in dry Finnish mode (submenu of the operation type).



Humid sauna mode (Bi-O)

Selection for operation in humid mode. (submenu of the operation type).



Temperature

Setting of the target temperature in the sauna cabin.



Humidity

Setting of the target humidity value in humid operation mode. %-sign indicates a connected humidity sensor (rel. air humidity control).



Auto-Start

Pre-set timer for later automatic switching on of the sauna up to 24 h in advance.



Light

Setting of the desired light intensity and light switching (light dimming 0 - 100%).



Timer

Setting for automatic switching on via calendar. A single event switching or regular week timer switching is possible.



Extended settings

Submenu for further settings. Like e.g. language, time, date, screensaver, child lock, heating time, etc.



Potential-free contact

Switch for the potential-free contact (output). This function has to be enabled via the service level settings.



Back

Return to the upper menu.

Hint:

The on/off switch  on the control panel front functions as a „home“ button during settings and allows you to quickly return to the start screen. Simply press shortly on this button. Please remember that all not yet confirmed settings will be lost in this case.



If you do not operate the ENTER button  for more than 20 seconds the control unit will return to the start screen. All not confirmed settings will be lost in this case.

Thanks to the integrated battery (CD2032 type, in control panel) all settings will be stored in the memory and will be retained even in the case of a very long time power loss.

New extension modules and optional equipment will be normally automatically detected and configured. Upon restart the control panel will show the corresponding new symbols in the menu navigation.

Symbol description - extended settings

„Extended settings“ sub-menu provides a range of additional functions, which normally need to be set only once or quite seldom.

Select the symbol  in the main menu and press shortly the ENTER button .



Language

Allows to set the language for the menu navigation. 19 languages are available:

DE, EN, FR, RU, ES, NL, IT, PL, SLO, FIN, TR, CZ, RO, BG, HU, HR, SK, DK, CRO, SE



Time

Here you can set the time of day.



Date

Here you can set the date, month and year.



Screensaver

Here you can set the interval, after which the display will show the screensaver with floating clock.



Sleep mode

Here you can set the interval, after which the control panel goes into sleep mode in order to save power. Rotate or press on the jog dial to wake up the unit.



Child lock

Here you can lock the unit with own Pin-code. It will be still possible to switch off the heater and to switch the cabin light.

Please observe the special advice below.



Heating time (Auto-Stop)

Here you can set the desired heating time. By private use - up to 6 hours, by commercial use - up to 12 hours or 99 hours.



Operation data

Here you can check the firmware version, the remaining time until the next service, as well as the contacts for service issues.



Display brightness

Here you can change the display brightness in three steps.



Holiday home mode



Here you can restrict the user's access to the minimum functions with an own Pin-code.



Important advice for Child Lock function

You can completely lock the control panel via  symbol with an individual pin-code. By active lock you can only switch off the heater (if it is heating) and switch the cabin light. If you attempt to reach any function you will be prompted to give in the pin-code.

How to reset the pin-code:

If you forgot the pin-code proceed as described to reset it. Press the on/off button or any other button to initiate the pin-code prompt, do not change the four „0“ digits, confirm the first „0“ with the button , then press and hold the button  pressed at the second „0“ (first two zeros turn green, the cursor will move to the third zero).

After approx 40 seconds all zeros will turn white. Now confirm all zeros (do not change them!), the display will return to the start screen and the Child Lock will be reset.

Graphic user interface (GUI) and the current climate conditions check

Thanks to the modern graphic user interface you can quickly access all functions and make necessary settings, as well as make a simple instant query for the current sauna climate condition.

The symbols on the start screen may be displayed in different colours, in order to indicate the current operation status - e.g. white colour for standby and red/blue colour for active heating.

For every selected symbol the control panel will display the meaning of this symbol at the top in one of 19 languages and will provide additional text hints by various settings. For language selection please see the next chapter.

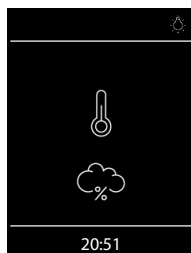

Start screen (standby mode)

In standby mode the display will show the symbol for the heater (thermometer). By Impera H in humid mode a cloud symbol will be additionally displayed underneath (symbolizes the vaporizer).

The „%“ sign inside cloud means that the humidity sensor has been detected on the control unit (means humidity control as per rel. air humidity).

The light symbol will appear at the top right corner if the light has been switched on. At the bottom the clock will be displayed.

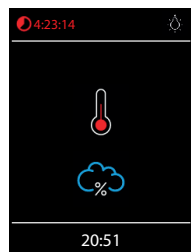

When the sauna is switch on - the thermometer symbol starts to pulse red during the heating up time, after this it will continuously light in red.

The countdown of the remaining heating time will be shown in red at the top left corner. You can stop the heating at any time by pressing on the on/off button  shortly.

The blue cloud means the active humid mode. Humidity regulation starts after the target temperature has been reached. After the humid mode a „sauna-dry“ program will start (up to 30 min., only the heater will run), unless this program has been disabled in setup.

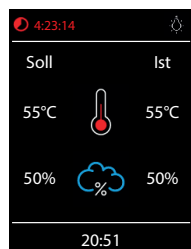

Checking the target and current sauna climate condition

You can quickly check the pre-set (target) and the real temperature (and humidity by Emotec H). Press the ENTER button  for approx. 3 seconds.

The target and current values will be displayed on the screen. The current values correspond to the values measured at the respective sensor.

If the 2nd sensor (bench sensor) is installed, then the current temperature will be shown as measured by this sensor.





Without humidity sensor only the pre-set proportional vaporizer switching will be shown, with humidity sensor the target and the real humidity in % will be shown.

Notice: Please pay attention that the shown values for the current temperature (humidity) are measured at the sensor location point. Because of the considerable differences in temperature in different parts of a sauna these values may vary from the values shown by the instruments mounted at the sauna wall. We recommend to maintain the climate as it is pleasant to you instead of blind orientation on some suggested values.

Operation and program settings



Sauna on / off

Press the  button on the control panel for approx. 3 seconds to switch the sauna on. Count-down runs    . The display will show the active heating state (see previous page). The cabin light will be also switched on.

To switch the sauna off press the  button shortly. By Emotec H models in humid mode the “sauna dry” program will switch on for 30 min. after the main operation. This time may be reduced or the program may be disabled in setup. After this program the sauna will switch off completely.

You can stop the “sauna dry” program at any time - just press the  button again shortly.



Light on / off

Press the light button on the control panel to switch the cabin light on or off. The light will switch on automatically if the heater is switched on, after the heater switches off the light will stay on for 30 minutes.



Sauna operation mode - dry sauna or humid (Bi-O) sauna (only ;_ bWdSH)

Press with the UP/DOWN button in the main menu the  symbol and choose the operating mode.

Select  for the dry Finnish sauna or  for the humid (Bi-O) sauna mode.



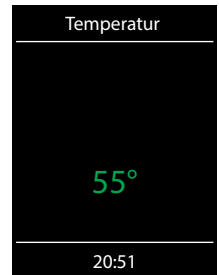

Temperature

Select and press the temperature symbol  in the main menu. A sub-menu will open and show the current value. Set the new temperature with the ENTER button. Press the ENTER button to confirm and exit. This setting can be also made during active heating.



Humidity (only ;_ bWdSH)

Select and press the humidity symbol  in the main menu. A sub-menu will open and show the last stored humidity value. Set the desired humidity with the UP/DOWN button. Press the ENTER button shortly to confirm the setting and exit. This setting can be also made during active heating (in humid mode).

With a connected humidity sensor (% sign appears inside cloud) the relative air humidity will be controlled. Without humidity sensor the humidity will be controlled in proportional to time way. “30%” then means 30% of the total heating time. The display will show the  symbol.

Please observe that with a humidity sensor the humidity setting will depend on the pre-set temperature. For safety reasons only the values to the left and under the curve may be selected. For instance at 60°C temperature you can set up to 40% rel. air humidity. In order to set a higher humidity you will need first to reduce the temperature.

If the sauna has been used in dry mode with high temperatures and you switch to the humid mode, the vaporizer will start to work only after the temperature drops under the max. allowed level (70°C).

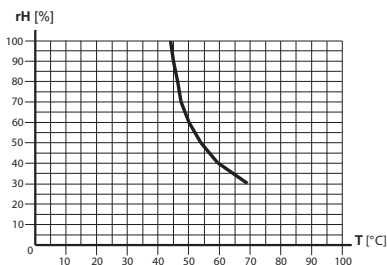

Time pre-selection (Auto-Start)

With this function you can program your sauna to switch on at a later time with up to 24 h delay. In the main menu select and press the timer symbol



with the ENTER button. A sub-menu will open and display „--:--“. Press the UP/DOWN button to set the hour for the desired automatic switch on time. Press the ENTER button to confirm and to jump to minutes. Now set the desired value for minutes and press the  button to save the setting and exit. At the start-screen you will see at the bottom right the blinking timer with the programmed time. This time means the time of day, not the delay in hours/minutes from the moment of setting.

To delete the pre-set Auto-Start timer simply press shortly on the On/Off button. The blinking timer indication shall disappear.



Attention! This function is only allowed to be used if your sauna is fitted with an approved safety system, which prevents the heater from being switched on in unsafe condition (e.g. a towel forgotten on the heater). Even in the case if your sauna has such an approved system, prove there are no objects forgotten on the heater. Risk of fire!



How to dim the cabin light

The light button on the control panel  allows to switch the light on/off quickly. In the main menu you can adjust the light brightness (dim the light 0-100%) over the same symbol. 0-10% in 1steps, 10-100% in 5steps.

Press on the  light symbol with the ENTER button. The cabin light will switch on (if not yet switched on) and a sub-menu will open and display the current light setting in %. Press the UP/ DOWN button to adjust the brightness to the desired value. Press the ENTER button to confirm the new setting and to exit the sub-menu.

Please observe that the light dimming will only function if a dimmable transformer or a regular resistive load incandescent bulb has been connected. Make sure to observe the minimum and maximum power load for the connected lamps (see specifications or contact your dealer).

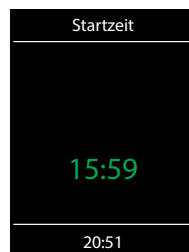



Timer (switch-on time pre-selection)

The timer function allows you to have your sauna switched on automatically with the desired climate condition at some time in the future. You have two possible options:





– single event (single time switching, not recurrent)

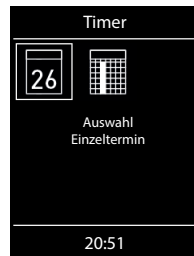

– week timer (regular, recurrent switching for the given day of the week, e.g. Monday, with up to 4 switching programs per day).



Attention! This function is only allowed to be used, if your sauna is fitted with an approved safety system, which prevents the heater from being switched on in unsafe condition (e.g. a towel forgotten on the heater). Even in the case if your sauna has such an approved system, prove there are no objects forgotten on the heater. Especially by active week timer make sure to check your sauna for safe condition regularly. Risk of fire!

For single event switching press on the  symbol in the main menu. In the sub-menu (see example above) press again on the  symbol for the single event programming.

Now set the day, month and year for the desired switching. Then in the new window set the start time (hours and minutes). Then in the new window set the operation type (dry Finnish sauna or humid sauna). Then as the last step set the preferred temperature and humidity (only by humid mode). The programming window will close after the last step. At the start screen in the bottom right corner you will now see the flashing programmed time (date and time, e.g. 15.01. and 18:30).

If you want to cancel this program just press shortly on the On/Off switch. The flashing date and time indication will disappear. This program will be also automatically cancelled if you switch the sauna manually.

For week timer programming press on the  symbol (week timer). A new window with seven numbered squares will open (1 to 7, 1 = Monday, 2 = Tuesday, and so on).

Notice: white colour means an empty program place. Green colour means there is a program for the given day.

Select a day of the week, for which you would like to assign a program (e.g. „1“ for Monday) and press on the ENTER button.

Notice: You can assign up to 4 programs to each day of the week. The max. heating time for each switching is 12 h. A 6 h pause must be observed after 12 h non-stop heating as per legal regulations. The next program may therefore start only after a 6 h break if the previous program duration has been set to 12 h. If you wish a shorter pause, then set the heating time to less than 12 hours.

Furthermore you can assign individual temperature (and humidity by Emotec H) to each program for automated sauna operation. This allows to implement flexible energy management schemes in your sauna - for instance during peak-off times you may set the sauna to run at lower temperatures with reduced energy consumption, so that it can then reach the full temperature faster at the main time of use.

Now select the program (1 of 4) and press the ENTER button.

1. Set the required start time (hours and minutes) - e.g. 9:30.
2. Set the required heating time (hours and minutes) - e.g. 3:30.
3. Set the required operation type - dry Finnish sauna or humid sauna (only Emotec H)
4. Set the required temperature.
5. Set the required humidity (only Impera H).

After the last step the control panel will return to the week overview. All days with assigned programs will be displayed in green. Repeat the above steps for every new program you may require (max. 4 per day). After you return to the main start screen you will see the indication of the next (earliest) switching time flashing in the bottom right corner (e.g. Monday, 9:30).

How to delete or change the week timer

In order to delete or change the program open the week timer via the main navigation menu.

1. Select the respective day of the week.
2. Select the respective program number.
3. Make the necessary adjustments (start time, heating time, temperature) or...
4. to delete the program, set the start time (hour and minutes) to „--“ and press the ENTER button two times shortly to confirm and exit.
5. The display will return to the week overview.



Notice: By active week timer you will always see the next earliest switching time displayed flashing in the bottom right corner. Also if you programmed several switching times or a combination of the single event switching and week timer switching.



Potential-free contact

With the potential-free contact (output) you can switch an external device up to 16 A on or off. This function has to be enabled in the setup menu and the external device has to be properly connected and configured.

Please observe that the potential-free contact output only provides a switching signal.

In the main navigation menu select the  symbol and press the ENTER button. In the sub-menu you can now select and press on the  (on) or  (off) symbol in order to make the respective switching.

If you cannot find the symbol of the potential-free contact in the main navigation menu please contact your local dealer to have this function enabled.



Extended settings

The sub-menu „Extended settings“ allows you to make additional settings, which normally need to be set only once or very seldom.

In the main navigation menu select the  symbol and press on the jog dial shortly.



Language

Here you can set the language for the menu navigation and messaging system. Press on the language symbol, in the respective sub-menu select the required language and press on the ENTER button shortly to confirm. All texts will be then shown in the new language. 18 languages are available.



Time (clock)

Set the hours and minutes by pressing the UP/DOWN buttons and confirm each setting by pressing shortly on the ENTER button .



Date

Here you can set the date (day, month, year). Stellen Sie durch drücken der AUF/AB-Tasten entsprechend den Tag, Monat, Jahr ein und bestätigen jede Auswahl durch drücken auf . Nach der letzten Einstellung (Jahr) kehrt das Gerät zum vorherigen Menü zurück.





Screensaver

This setting defines the period of time after which the control panel will enter the screensaver mode if no button has been operated. In this mode the display brightness will be reduced to the minimum and the display will show the current time (or EOS-Logo et al enlarged) floating across the screen. Press the UP/DOWN buttons or press on the on/off button shortly in order to return to the start screen.



Sleep mode





This setting defines the period of time after which the control panel will enter the sleep mode.

In sleep mode the display will be switched off completely. Press ,  button or press on the on/off or light button to wake the control panel. This function is only active if the heater is not switched on.



Child lock / Operation lock

You can lock the control panel with the individual 4-digit pin-code in order to prevent the unauthorized access.



In order to lock the control panel select the „lock“ symbol and press the  button shortly. A sub-menu will open and display „0000“. You can now replace the zeros with your personal 4-digit pin code. Press ,  button to select a number, press on the  button to confirm it and to jump to the next digit.

After the 4th digit confirmation the display will return to the start screen and the unit is now locked. No settings are possible.



Notice: make sure to remember the pin-code!

For safety reasons it is still possible to switch off the heater (interrupt active heating) and to switch the light while the unit is locked. All other functions will be locked.

By an attempt to operate the control panel a pin code prompt will appear.

To unlock the unit press ,  in order to call the pin code prompt. Now give in your pin code. The unit is now unlocked.

How to reset the pin code by a locked unit

Touch any button except light to launch the pin code prompt, do not change the „zero“ values, confirm the first zero (press ), then hold the button  pressed by the second zero (first two zeros turn green, the cursor jumps to the third zero).

After approx. 40 seconds all four zeros will turn white. Now confirm all four zeros with the ENTER button - upon exiting the unit will be unlocked.



Heating time

Here you can set the required heating time duration for your sauna bath.

By private use the max. heating time is limited to 6 hours. By commercial use the max. heating time may be limited to 6 hours, 12 hours or set to unlimited. This limitation should be set in hardware during the installation and setup (jumper 5 setting)

Press with the ENTER button on the  symbol and set the required heating time in hours and minutes. This setting will be then valid for every manual sauna switching. You can of course stop the heating earlier at any moment.

After switching the sauna on the remaining heating time will be displayed as a countdown clock in the upper left corner. So you can check at a glance the remaining heating time of your sauna.

Please observe that after the humid mode operation (only Impera H) the sauna heater will be switched in the „sauna dry“ mode in order to dry your sauna cabin. The default sauna dry mode duration is 30 minutes. This time may be reduced (also the pre-set temperature and fan operation time maybe adjusted) in the setup menu. Please contact your dealer for further details.

The heating time may be changed with 1 minute steps. The minimal heating time is 1 minute.

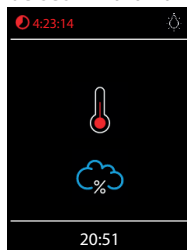



Operation data

Here you can check the important information concerning your control unit (sauna) operation.



Firmware - allows to check the currently installed firmware version. Press the UP/DOWN button to switch between two possible parameters. „Panel Vx.xx“ - shows the firmware in control panel, „Mod-LS Vx.xx“ - shows the firmware in the main relay unit (x stands for a number). Press on the ENTER button to close this sub-menu.



Service intervals - allows to check the remaining time until the next pending servicing / maintenance of your sauna. The intervals will be set by your dealer (installer) during the installation and setup.



Contacts - shows you the contact information of the sauna control unit manufacturer or your dealer (installer). This information will be also displayed by faults along with the error messages.



Display brightness

Here you can set the display brightness in 3 stages.



Holiday home mode

With this function you can restrict the access to the control panel with your own pin code down to the bare minimum of functions. All other functions will be disabled and their symbols will not be displayed.

Following settings are possible when the holiday home mode is active:



- Sauna on / off
- Light on / off
- Selection of the operation mode - dry or humid (only by Emotec H)
- Temperature setting
- Humidity setting (only by Emotec H)

To activate the mode press on the  symbol. A pin code prompt window with default „0000“ will open. Instead of the four zeros, you can now enter your own PIN code. Press the UP/DOWN button to select a number and press shortly the ENTER button to confirm it and to jump to the next digit. After the 4th digit the display will return to the start screen and the holiday home mode will be activated.

Hint: To cancel the activation while setting the code press shortly on the main on/off button.

To unlock the control panel press the UP/DOWN button to reach the main navigation menu in which you find the  symbol at the last place. Press on this symbol. The pin code prompt window will open („0000“ default display). Give in your pin code to unlock the control panel.

How to reset the pin code by a locked unit

Select the  symbol and press the ENTER button  for approx. 1 minute. The pin code prompt will open, confirm all four zeros with the jog dial. After the 4th digit the control panel will be unlocked and will return to the start screen. The pin code will be reset.

Service- and Setup

The control unit provides an extensive scope of functions for setup and fine-tuning of the sauna equipment in order to optimize sauna operation. **This setup menu is protected with a PIN code and should not be accessible to the end users.**

Hint: a short version of the operation manual without setup and installation is included with every controller. Hand it over to the end client and retain this manual for yourself.

In the main menu select the  symbol and press the ENTER button for approx. 6 - 7 seconds until a pin code prompt window opens.

Your PIN code: **5349**

Please make sure to retain this PIN code at the safe place and do not disclose it to the end clients in order to prevent unauthorized access to the basic setup and safety-relevant features.



Press the ENTER button for approx. 6 - 7 seconds.

>>



Give in the PIN code

Service & setup level user interface

Depending on the model (D/Di or H/Hi) the available functions will be shown as symbols. By H/Hi models some symbols will not fit the window and will be hidden. Press the UP/DOWN button to scroll and show them on the display (the window scrolls down).

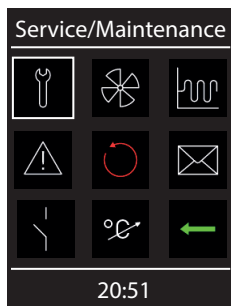

Service level interface
Impera D



Service interface Impera H
(immediately visible symbols)



interface Impera D
(the lower hidden part of the window)

Symbol description



Service intervals

Intervals for servicing & maintenance in hours.



Basic-Setup

Setting of the sauna use type and of the heater type.



Fan

Fan speed settings.



Reset

Reset to the factory default settings, all individual settings will be deleted.



Refilling time

Grace time to refill the vaporizer (only Impera H)



Contact details

Displays stored contacts.



Afterheating time

Duration of the „sauna dry“ program after humid operation (only Impera H)



Potential-free contact

Enables or disables the potential-free contact switching function.



Afterheating temperature

Temperature for the „sauna dry“ program in °C. (only Impera H)



Temperature adaptation

Setting for the temperature offset +/- °C.



Fan running time

Fan operation time after humid operation.



back

Exits and returns to the main menu.



Hysteresis

Adjustment of the hysteresis curve.

Settings



Service intervals

Allows to set the intervals for servicing and maintenance. Upon expiry the control panel will remind the user for a short time upon every switching about the pending servicing. The end user can check the remaining time to the next servicing in the extended settings menu. This function allows as well to keep track of the total operation time of the sauna.

Default setting by domestic use - 500 hours.

Default setting by commercial use - 2500 hours.



Fan

Here you can set the fan operation speed in 3 stages or disable it. If activated, the fan will automati-

cally switch on with the heater (synchronous operation). In „sauna dry“ program the fan will always operate at the highest speed.



Refilling time (only Bi-O heaters)

Here you can set the grace time which the end user has to refill the vaporizer after the water shortage alarm. If the vaporizer has not been refilled within this time, it will be switched off (overheating protection). This function is especially important for Bi-O heaters with manual refilling.



After-heating time (only H models)

Here you can set the time for the „sauna dry“ program after the humid operation. Factory default setting is 30 minutes. After every humid operation the sauna will then switch on in dry Finnish mode in order to dry the cabin. We recommend to use this function in combination with the exhaust fan in order to remove the humidity and dry the sauna cabin.



After-heating temperature (only H models)

This functions allows to set the temperature for the „sauna dry“ program. Factory default setting is 90°C.



Fan running time (only H models)

Here you can set how long the fan should operate after the finnish or humid mode operation of 0-60. Factory default setting is 30 minutes. We recommend to use this function in combination with the „sauna dry“ program in order to remove the humidity and dry the sauna cabin.



Hysteresis

Allows to adjust the hysteresis within a +/- 10°C range. This adjusts the tolerance level around the temperature set-point and influences how often the heater will be switched on or off by temperature changes. For instance at 90°C target temperature and hysteresis set to 5°C the control unit will switch the heater on at 85°C and off at 95°C respectively. This allows you to better adjust the sauna heater to the specific sauna cabin size and layout.

Attention! The smaller hysteresis value will lead to considerably increased number of relay switchings, which reduces the service life expectation of the control unit! Setting 1 is not recommended.

The factory default setting is 5K. Make sure to adjust this value with care!



Sauna use type

Here you can set the sauna use type to private (residential) use or commercial use. The control unit will adjust relevant settings accordingly. For instance the maximum heating time limitation.



Reset

Allows you to reset the unit back to the factory default settings. All individual settings will be lost. The control unit will restart and will prompt to perform the basic setup steps as by the first switching.



Contact details

Here you can check the stored contact details. By default the contacts of the control unit manufacturer will be shown. If an optional micro-SD card with personalized firmware is inserted, the individual contact details will be shown.



Potential-free contact

Allows to enable (✓) or disable (X) the potential-free contact switching function. If enabled the corresponding symbol will be shown in the main navigation menu, so that the end users may switch the connected external equipment. By default this feature is disabled.

The middle symbol  allows to synchronize the volt-free contact switching with the S1 output. This means the contact between terminals 3 and 4 will be closed if the sauna is switched on.



Temperature adjustment (offset)

With this function you can adjust the displayed set point temperature of the control unit in relation to the real set point value. For instance if the thermometer shows air temperature 5°C below the set point value you can compensate this difference by adjusting the temperature offset to +5K. The control unit will then heat with the effective set point 5K above the displayed set point which allows to reach a higher temperature in order to match the value shown on the thermometer.

Notice: Since this function bears certain risks, it may be only used by experienced and appropriately qualified persons and should be properly tested.

Possible adjustment range is from -10K to +10K.

Please make sure to observe the maximal allowed temperatures as per norm EN 60335-2 part 53.



Back (exit service level)

Select and press the  symbol in order to exit the service level. Alternatively you can press shortly the „Home“ button (on/off button).

The service level will be automatically closed if you do not operate the ENTER button for 15 seconds.

The control panel will then return to the start screen.

Troubleshooting (error messages)

The control unit is able to detect various errors and will display an error message on the screen. The errors will be displayed in text form which allows to identify the reason of the fault easier and to rectify it faster. Additionally the control panel will display on alternating basis the contact information, so that the end user could contact the manufacturer or the dealer immediately without having to search for this information in the manual or other records.

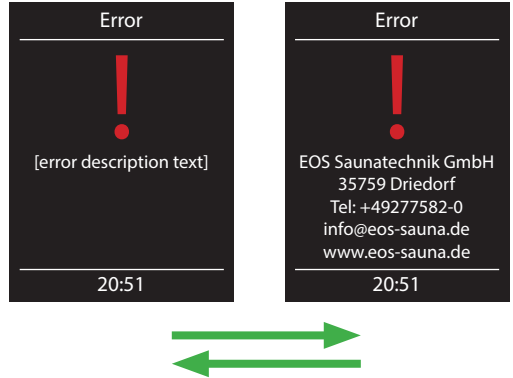

Errors / Error messages

Display remains dark

Sensor fault

Thermofuse blown

Water shortage

No Bus communication

Unknown error

If any other unidentified error messages appear, please contact EOS service. Make sure to supply the serial number, fault details and other relevant information.

Reason / Troubleshooting

- No power supply - check fuses, check cables.
- Switch-Off switch in off position - check the device's main switch for correct position.
- Faulty connection to control panel - check the link cable (rely box - control panel) for reliable connection.
- Control panel in sleep mode - rotate the jog dial / press UP/DOWN or ENTER button.
- Faulty connection to the main sensor - check the sensor and cables for reliable connection.
- Faulty sensor- get the sensor replaced by the dealer.
- Faulty connection - check the white cable (loose wire, faulty contact, etc.)
- Thermofuse blown because of overheating - check the possible reason for overheating, replaced the fuse (one spare fuse is included with every controller).
- Too little water in vaporizer - refill water. Observe the pre-set grace time for refilling, otherwise the vaporizer will be shut-down!
- By automatic refilling - check the water supply line, check the FWA water level control device.
- Check the cable connection between the relay box and the control panel.
- Restart the control unit; if the fault persists, contact the dealer or EOS service.
- Check cable connections and restart the control unit; if the fault persists, contact the dealer or EOS service.

The device „Switch-off“ switch

The control unit is equipped with a “Switch-off” rocker switch.

You will find this switch on the top side of the housing by Econ series control units and on the left side of the main relay box by control units of Emotec, Impera and EmoTouch series.

This switch allows to switch the control unit to the standby mode (notice the heating will not start), to switch the control unit completely off (disconnect from power) or to switch the control unit off but to leave the light switched on.

Notice: if you leave the Econ control units switched off for more than 24 h all personal settings will be lost. You will have to repeat setup.

 **Attention!** Parts of the printed circuit board will still remain energized in the switched off condition! Risk of electric shock!

Press the switch on the lower side of the rocker to the first latch (**switch setting 0**). The switch will be in the middle position. The unit is now completely switched off (disconnected).

To turn the light on in the cabin while the unit is still disconnected push the left side of the rocker to the second latch (**switch setting II**).

To make the unit ready for operation, switch back to the initial position (**switch setting I**). The unit will return to stand-by mode.



Switch-off rocker switch by Dicia, Impera, EmoTouch models

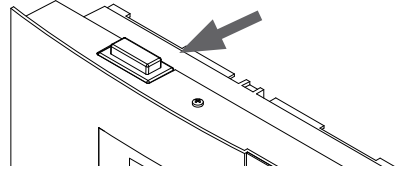

Switch-off rocker switch by Econ models

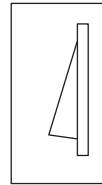

Device switched on.
(default Position I)

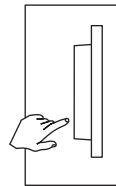

Device switched off
(completely);
Position 0.

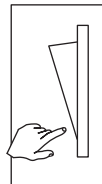

Light enabled;
Device switched off.
Position II.



Device switched on.
Position I.

AUROOM

Our Saunas Your Wellness

www.auroom.ee

Please keep this address in a safe place together with the installation guide.

To help us answer your questions quickly and competently please provide the information printed on the type shield including the model, item no. and serial no., in all inquiries.

Equipment commissioning date:

Stamp and signature of the authorized electrician:

General Terms and Conditions of Service

I. Scope

Unless otherwise agreed in writing in a specific case, these terms and conditions of service shall apply to service operations, including examining and repairing complaints. All our existing or future legal relationships shall be governed solely by the following terms and conditions of service. Our recognition of any conflicting terms and conditions of the Ordering Party shall be conditional upon our having given our express written consent to their applicability. We hereby expressly object to any terms and conditions of the Ordering Party contained in its General Terms and Conditions of Business or order confirmation. If order confirmations or deliveries are accepted without reservation, this shall not be deemed to constitute recognition of such terms and conditions. Any ancillary agreements or amendments must be confirmed in writing.

II. Prices and Payment Terms

The Ordering Party shall bear the following costs in connection with the service operation:

- Disassembly/assembly and electrical (de-) installation
- Transportation, postage and packaging
- Function testing and troubleshooting including inspection and repair costs

There shall be no third-party billing.

III. Performance Obligations / Ordering Party's Cooperation

The Ordering Party shall provide free-of-charge assistance to the manufacturer in carrying out the service operation.

In the case of a warranty claim, the manufacturer shall make the replacement parts necessary for the service available to the Ordering Party free of charge.

IV. Service Visit by the manufacturer

In the event that it is essential that a manufacturer employee carry out the service operation on site, this must be agreed in advance. Where the main reason for the service call is not the fault of the manufacturer, any costs incurred shall be recharged to the Ordering Party after the service visit.

V. Liability

The manufacturer shall assume liability in accordance with the currently applicable statutory regulations. The packaging for all of our products is designed for the shipping of individually packed goods (pallet). We expressly point out that our packaging is not suitable for individual

shipments via parcel post. The manufacturer shall accept no liability for damage incurred as a result of improper packaging in an individual shipment.

VI. Manufacturer's Warranty

The manufacturer's warranty shall apply only in the event that installation, operation and maintenance have been carried out in accordance with the manufacturer's specifications contained in the assembly instructions and instructions for use.

- The warranty period shall commence from the date on which proof of purchase is provided and shall be limited, in principle, to 24 months.
- Warranty services shall be performed only if the proof of purchase relating to the equipment can be presented.
- Any and all warranty claims shall become void if modifications are made to the equipment without the manufacturer's express consent.
- Any warranty claim shall likewise become void in the case of defects that arise due to repairs or interventions made by unauthorized persons or due to improper use.
- In the case of warranty claims, the serial and article numbers must be indicated together with the designation and a meaningful description of the fault.
- This warranty shall cover defective equipment parts, with the exception of normal wear parts. Wear parts shall include, among other things, light sources, starters, gas or oil pressure dampers as well as acrylic glass panes, tubular heating elements and sauna heater stones.
- Only original replacement parts may be used within the warranty.
- Service visits by outside companies shall require a written order to be issued by our service department.
- The equipment in question shall be sent to our service department by the Ordering Party and at its expense.
- Electrical assembly and installation work, including in the event of service or replacement, shall be carried out at the Customer's expense and shall not be borne by the manufacturer.

Complaints in respect of our products shall be reported to the specialist trader responsible and shall be exclusively handled via the latter.

The manufacturers General Terms and Conditions of Business, as amended, shall apply in addition to the foregoing terms and conditions of service.